

AXE MICROPROCESS RPM&LINE-SPEED CONTROLLER METER MMR Series

■ Features

- ⊙ Accept more type sensors (switch, encoder, proximity switch, ...etc) finish RPM/LINE SPEED control
- ⊙ Accuracy 0.03% F.S.
- ⊙ Input range (0~50KHz), Readout range (0~99999)
- ⊙ Decimal point can be modified
- ⊙ LINE-SPEED unit can be modified
- ⊙ Input pulse of revolution can be modified (1~99999)
- ⊙ Diameter (LINE-SPEED)/scale (RPM) can be modified (0.0001~9.9999)
- ⊙ Display average times can be modified (1~99)
- ⊙ 15BIT DAC analog output can be modified, 0~10V/4~20mA by inside switch jumper
- ⊙ Two alarm function
- ⊙ Man-machine interface, easy to operate
- ⊙ 0.56" highlight display
- ⊙ BAUD RATE: 19200/9600/4800/2400
- ⊙ RS485 Communication interface, Protocol MODBUS RTU MODE
- ⊙ EEPROM Saving, data safekeeping about 10 years
- ⊙ Modified inside parameter, must have pass code

■ Name of Parts

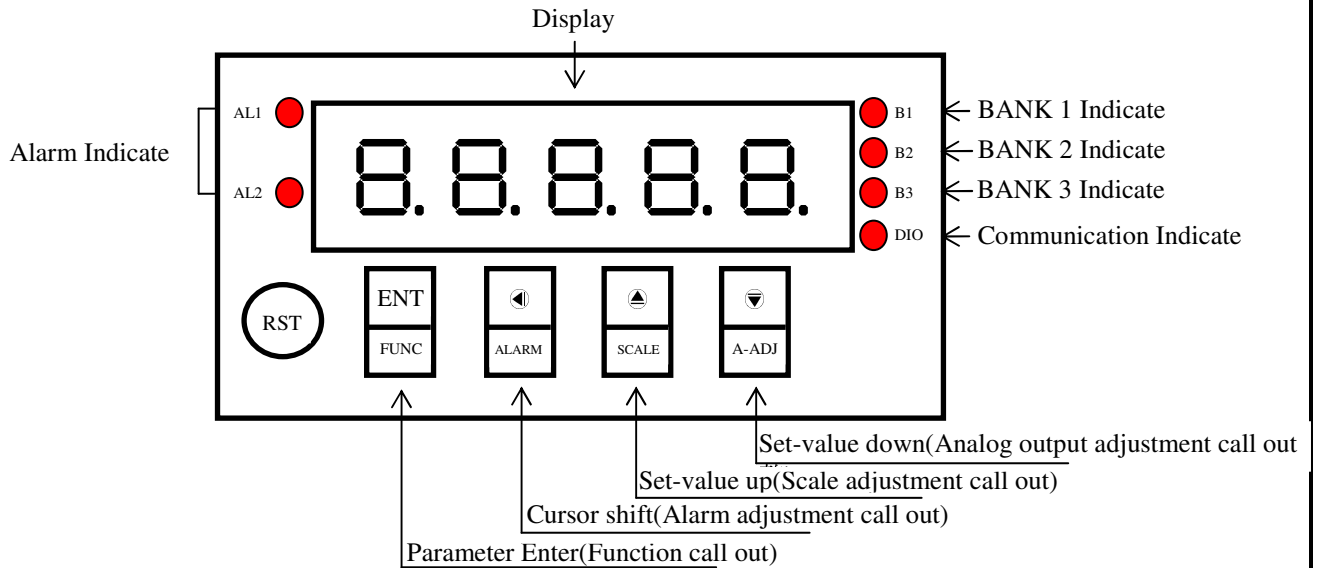

■ Connect Diagram

⊙ Contact input (PNP)

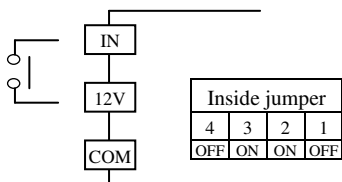

⊙ Contact input (NPN)

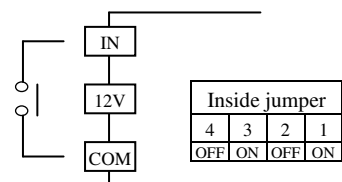

⊙ CMOS input (12V or 15V)

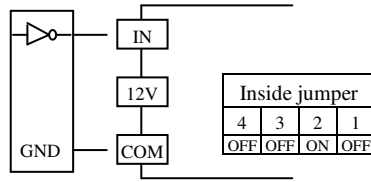

⊙ TTL input (5V)

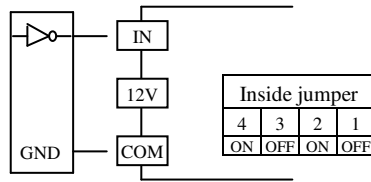

⊙ Sensor input (PNP 12V)

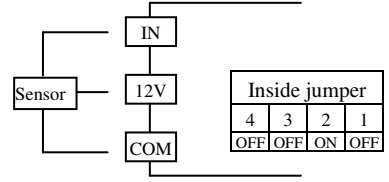

⊙ Sensor input (NPN 12V)

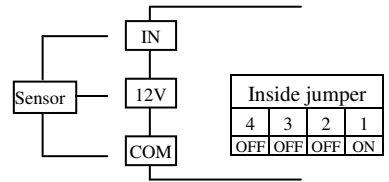

■ Analog output function jumper table

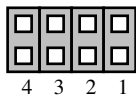

Position 1&3 ON: DC 4~20 mA OUTPUT
Position 2&4 ON: DC 0~10V OUTPUT

■ Input function jumper table

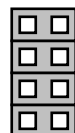

4	Position 4	ON: TTL	OFF: CMOS
3	Position 3	ON: 0~50Hz	OFF: 0~10KHz
2	Position 2	ON: PNP	
1	Position 1	ON: NPN	

Key Introduce		Operation Manual	
☰ Key Function	1.In normal display,The key function is call out setting group 2.In parameter setting page,The key function is data Enter , and goto next page		
◀ Key Function	1.In normal display,The key function is call out alarm value setting page 2.Into parameter setting page,the parameter mark&data is alternate display,If need modify data can press shift key into setting procedure,The display is lock parameter data,this time must let off key about 0.2 sec.press again,the cursor(twinkle express)is cycle moving left. (Key Response about 0.2 sec)		
▲ Key Function	1.In normal display,The key function is call out adjustment display scale page 2.Into parameter setting page,the parameter mark&data is alternate display,If need modify data can press up key into setting procedure,The display is lock parameter data,this time must let off key about 0.2 sec.press again,the parameter data will increment. (Key Response about 0.2 sec)		
▼ Key Function	1.In normal display,The key function is call out adjustment analog output ZERO&SPAN page 2.Into parameter setting page,the parameter mark&data is alternate display,If need modify data can press down key into setting procedure,The display is lock parameter data,this time must let off key about 0.2 sec.press again the parameter data will decrement. (Key Response about 0.2 sec)		
▲&▼ Key Function	In setting group or setting page press ▲&▼ key return normal display,but if in setting page the modify data will be lost		
No Key in anything	In setting group or setting page no key in anything about 2 minutes,return normal display,but if in Setting page the modify data will be lost		
Step	Parameter Mark Description	Parameter Mark	Operation Manual
1	Normal display	1 2 3 4 5	Press ☰/FUNC key into P.COD setting page
2	P.COD(Pass code input page)	P . C o d	1.Key in 5 digit pass code with ◀ or ▲ or ▼ key 2.Press ☰ key,the pass code is right into setting group , otherwise return normal display
		0 0 0 0 0	
3	SYS(System setting group)	S Y S	1. Select setting group with ◀ key 2. Press ☰ key into setting page of selection setting group
	ROP(Alarm setting group)	r o P	
	AOP(Analog output setting group)	A o P	
	DOP(Communication setting group)	d o P	
4	SYS(System setting group)	S Y S	Press ◀ key decide SYS setting group , press ☰ key into Dp setting page
4-1	DP(Decimal Point setting page)Default=0	d P	1.Decide decimal point position with ▲ or ▼ key (0 to 4) 2. Press ☰ key enter data and into TYPE setting page
		0	
4-2	TYPE(Display Type) Default=RPM	t Y P E	1.Decide display type with ▲ or ▼ key(RPM/LINE) 2.Press ☰ key enter data,If select LINE into UNIT setting page, otherwise into PPR setting page
		r P ā	
4-3	UNIT(Line Speed Unit) Default=METER	U n i t	1.Decide line speed unit with ▲ or ▼ key(METER/FOOT/YARD) 2.Press ☰ key enter data and into PPR setting page
		ā E t E r	
4-4	PPR(Pulse Per Revolution) Default=1	P P r	1.Decide pulse per revolution with ◀&▲&▼ key(1~99999) 2.Press ☰ key enter data and into TBASE setting page
		0 0 0 0 1	
4-5	TBASE (Sampling Time Base) Default=0.1	t B A S E	1.Decide sampling time base with ◀&▲&▼ key(0.1~99.9 秒) 2.Press ☰ key enter data and into AVG setting page
		0 0 0 0 . 1	
4-6	AVG (Display Average times) Default=1	A v G	1.Decide display average times with ◀&▲&▼ key(1~99) 2.Press ☰ key enter data and into CODE setting page
		0 0 0 0 1	
4-7	CODE(Pass Code) Default=0	C o d E	1.Decide pass code with ◀&▲&▼ key(0~99999) 2.Press ☰ key enter data and into LOCK setting page
		0 0 0 0 0	
4-8	LOCK(Panel Lock) Default=NO	L o C k	1.Decide panel lock with ▲&▼ key(NO or YES) 2.Press ☰ key enter data and return SYS setting group
		n o	

5	ROP(Alarm setting group)	ROP	Press ◀ key decide ROP setting group,press Ⓜ key into ACT1 setting page
5-1	ACT1(Alarm Active 1 setting page) Default =HI	ACT1	1.Decide active 1 with ▲ or ▼ key(HI or LO) 2.Press Ⓜ key enter data and into ACT2 setting page
		HI	
5-2	ACT2(Alarm Active 2 setting page) Default =HI	ACT2	1.Decide active 2 with ▲ or ▼ key(HI or LO) 2.Press Ⓜ key enter data and into HYS1 setting page
		HI	
5-3	HYS1(Alarm Hysteresis 1 setting page) Default =0	HYS1	1.Decide Hysteresis 1 with ◀ or ▲ or ▼ key(0~999) 2.Press Ⓜ key enter data and into HYS2 setting page
		0000	
5-4	HYS2(Alarm Hysteresis 2 setting page) Default =0	HYS2	1.Decide Hysteresis 1 with ◀ or ▲ or ▼ key(0~999) 2.Press Ⓜ key enter data and into DEL1 setting page
		0000	
5-5	DEL1(Alarm Delay 1 setting page) Default =0	DEL1	1.Decide delay 1 with ◀ or ▲ or ▼ key(0~99.9 sec) 2.Press Ⓜ key enter data and into DEL2 setting page
		0000.0	
5-6	DEL2(Alarm Delay 2 setting page) Default =0	DEL2	1.Decide delay 2 with ◀ or ▲ or ▼ key(0~99.9sec) 2.Press Ⓜ key enter data and return ROP setting group
		0000.0	
6	AOP(Analog output setting group)	AOP	Press ◀ key decide AOP setting group , press Ⓜ key into ANLO setting page
6-1	ANLO(A/O Zero According to Display setting page)Value on EEPROM reset=0	ANLO	1.Decide ANLO with ◀ or ▲ or ▼ key(0~99999) 2.Press Ⓜ key enter data and into ANHI setting page
		00000	
6-2	ANHI(A/ O Span According to Display setting page)Value on EEPROM reset=99999	ANHI	1.Decide ANHI with ◀ or ▲ or ▼ key(0~99999) 2.Press Ⓜ key enter data and return AOP setting group
		99999	
7	DOP(Communication setting group)	DOP	press ◀ key decide DOP setting group,press Ⓜ key into ADDR setting page
7-1	ADDR(Communication –Address setting page) Value on EEPROM reset=0	ADDR	1.Decide address with ◀ or ▲ or ▼ key(0~255) 2.Press Ⓜ key enter data and into BAUD setting page
		00000	
7-2	BAUD(Communication Baud Rate setting page)Value on EEPROM reset=19200	BAUD	1.Decide baud rate with ▲ or ▼ key(19200,9600,4800,2400) 2.Press Ⓜ key enter data and into PARI setting page
		19200	
7-3	PARI(Communication Parity Check setting page)Value on EEPROM reset=n82	PARI	1.Decide parity check with ▲ or ▼ key(n82,n81,even,odd) 2.Press Ⓜ key enter data and return DOP setting group
		n.8.2	
Step	Parameter mark description	Parameter mark	Operation manual
8	Normal display	12345	Press ◀/ALARM key about 3 sec,into AL1 1setting page
8-1	AL1 (Alarm value 1 setting page) Value on EEPROM reset=0	AL1	1.Decide alarm value 1 with ◀ or ▲ or ▼ key(0~99999) 2.Press Ⓜ key enter data and into AL2 setting page
		00000	
8-2	AL2 (Alarm value 2 setting page) Value on EEPROM reset=0	AL2	1.Decide alarm value 2 with ◀ or ▲ or ▼ key(0~99999) 2.Press Ⓜ key enter data and return normal display
		00000	
Step	Parameter mark description	Parameter mark	Operation manual
9	Normal display	12345	Press ▲/SCALE key about 3 sec,into SCALE setting page

9-1	SCALE (Display Scale setting page) Value on EEPROM reset=1	SCALE 1.0000	1.Decide scale with ◀ or ▲ or ▼ key(0.0001~9.9999) 2.Press Ⓜ key enter data and return normal display RPM(scale = 0.0001~9.9999), LINE-SPEED(rotation diameter = 0.0001~9.9999M)
Step	Parameter mark description	Parameter mark	Operation manual
10	Normal display	12345	Press ▼/A-ADJkey about 3 sec,into AZERO adjustment page
10-1	AZERO(Analog Output Zero Adjustment page) Value on EEPROM reset=0	AZERO 00000	1.Adjustment analog output zero with ◀ or ▲ or ▼ key(±9999) 2.Press Ⓜ key enter data and into ASPAN adjustment page
10-2	ASPAN(Analog Output Span Adjustment page) Value on EEPROM reset=0	ASPAN 00000	1.Adjustment analog output span with ◀ or ▲ or ▼ key(±9999) 2.Press Ⓜ key enter data and return normal display
Appendix	Error Mark description	Error Mark	Analyze & Description
1	Input over range error detect	1 o F L	Input signal over range(0~50KHz)
2	Display over range error detect	d o F L	Input signal over display range(99999)
3	EEPROM error detect	E - 00 n o Y E S	1.External interference when EEPROM read/write 2.EEPROM write over 100 million times(guarantee 10 years) Please power reset,if still display E-00,doing following step: 1. E-00 & No alternate display for inquire reset EEPROM 2. Decide Yes with ▲ or ▼ key,press Ⓜ key return normal display 3. EEPROM was reset,Please follow step 1~10 set again

MMR Modbus RTU Mode Protocol Address Map

Data format 16Bit/32Bit,sign bit

8000~7FFF(-32768~32767)/80000000~7FFFFFFF(-2147483648~2147483647)

Address	Name	Description	Accept
0000	DP	DP, input range 0000~0004(0~4)0:10 ⁰ ,1:10 ⁻¹ ,2:10 ⁻² ,3:10 ⁻³ ,4:10 ⁻⁴	R/W
0002	TYPE	TYPE, input range 0000~0001(0~1)0:RPM,1:LINE	R/W
0004	UNIT	UNIT, input range 0000~0002(0~2)0:METER,1:FOOT,2:YARD	R/W
0006	TBASE	TBASE, input range 0001~03E7(1~999)	R/W
0008	AVG	AVG, input range 0001~0063(0~99)	R/W
000A	ACT1	ACT1, input range 0000~0001(0~1)0:HI,1:LO	R/W
000C	ACT2	ACT2, input range 0000~0001(0~1)0:HI,1:LO	R/W
000E	HYS1	HYS1, input range 0000~03E7(0~999)	R/W
0010	HYS2	HYS2, input range 0000~03E7(0~999)	R/W
0012	DEL1	DEL1, input range 0000~03E7(0~999)	R/W
0014	DEL2	DEL2, input range 0000~03E7(0~999)	R/W
0016	ADDR	ADDR, input range 0000~00FF(0~255)	R/W
0018	BAUD	BAUD, input range 0000~0003(0~3)0:19200,1:9600,2:4800,3:2400	R/W
001A	PARI	PARI, input range 0000~0003(0~3)0:N82,1:N81,2:EVEN,3:ODD	R/W
001C	AZERO	AZERO, input range D8F1~270F(-9999~9999)	R/W
001E	ASPAN	ASPAN, input range D8F1~270F(-9999~9999)	R/W
0020	BANK	BANK, input range 0000~0002(0~2)0:BANK0,1:BANK1,2:BANK3	R/W
0022	LOCK	LOCK , input range 0000~0001(0~1)0:NO,1:YES	R/W
0024	PPR	PPR , input range 00000001~0001869F(1~99999)	R/W
0028	CODE	CODE, input range 00000000~0001869F(0~99999)	R/W
002C	SCALE	SCALE, input range 00000001~0001869F(1~99999)	R/W
0030	AL1	AL1, input range 00000000~0001869F(0~99999)	R/W
0034	AL2	AL2, input range 00000000~0001869F(0~99999)	R/W
0038	ANLO	ANLO, input range 00000000~0001869F(0~99999)	R/W
003C	ANHI	ANHI, input range 00000000~0001869F(0~99999)	R/W
0040	DISPLAY	Display value range 00000000~0001869F(0~99999)	R